

Design Noir: The Secret Life of Electronic Objects

Anthony Dunne and Fiona Raby

Published by August / Birkhäuser

Placebo project

The Placebo project is an experiment in taking conceptual design beyond the gallery into everyday life. We devised and made eight prototype objects to investigate peoples' attitudes to and experiences of electromagnetic fields in the home, and placed them with volunteers. Made from MDF and usually one other specialist material, the objects are purposely diagrammatic and vaguely familiar. They are open-ended enough to prompt stories but not so open as to bewilder.

Once electronic objects enter people's homes, they develop private lives, or at least ones that are hidden from human vision. Occasionally we catch a glimpse of this life when objects interfere with each other, or malfunction. Many people believe that mobile phones heat up their ears, or feel their skin tingle when they sit near a TV, and almost everyone has heard stories of people picking up radio broadcasts in their fillings. We are not interested in whether these stories are true or scientific, but we are interested in the narratives people develop to explain and relate to electronic technologies, especially the invisible electromagnetic waves their electronic objects emit.

The Placebo objects are designed to elicit stories about the secret life of electronic objects – both factual and imagined. Homes for the objects were found through a variety of means, including adverts in a London listings magazine, workshops at the Victoria & Albert museum, a window display in Selfridges department store on Oxford Street and an article in a national newspaper. Potential adopters filled out application forms detailing any unusual experiences with electronic products, their attitude to electromagnetic waves and their reasons for choosing a particular object. Once their allotted time with the adopted object was up, we interviewed the people taking part in the project and collaborated with photographer Jason Evans to create images that pick up on and amplify details revealed during the interviews.

Designers cannot always solve problems, we cannot switch off the vast electromagnetic networks surrounding us all. Although we cannot change reality, we can change people's perception of it. Like a medical placebo, the objects in this project do not actually remove or counteract the cause for concern, but they can provide psychological comfort. The Placebo project is definitely not scientific: although aware of ethnographic and anthropological methodologies, we chose to adopt a more informal process in this case. We wanted to find out if people are more receptive to radical ideas than industry acknowledges, and to test our ideas about aesthetic meaning and electronic technology. We accept that the group of adopters was self-selecting. We also accept that they are probably exceptional people. But they are real people, and anything we discovered would be grounded in reality rather than fiction.

It is unlikely that any of the Placebo prototypes will make it into 'reality', at least not through the commercial marketplace. As one-offs, these products would be prohibitively expensive, and even if they were affordable, or mass-producible, their highly specific aesthetic function would mean they might only be useful for a limited period of time, like a book or video. We like the idea that these products would be available for rent, providing a service in the form of a reflective experience. Living with them for a while might encourage the borrower to think about their environment in a different way, especially in relation to electromagnetic fields.

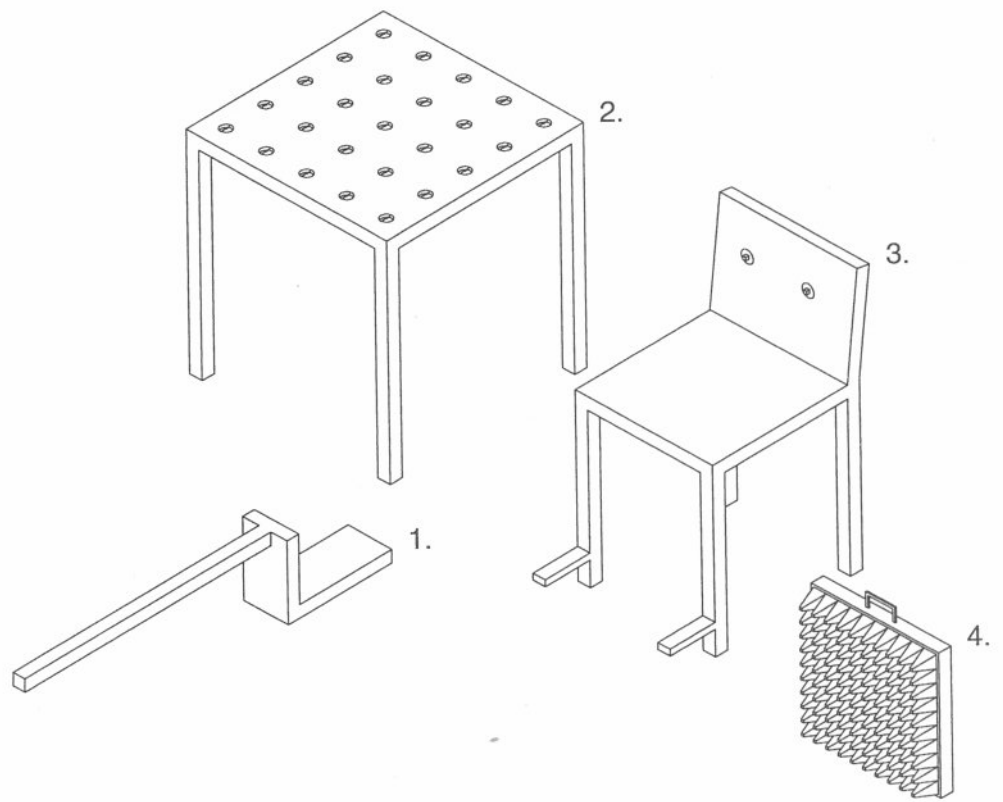

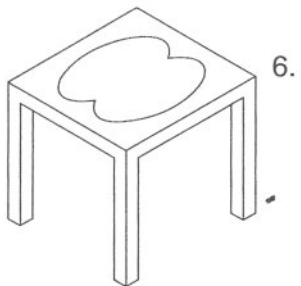
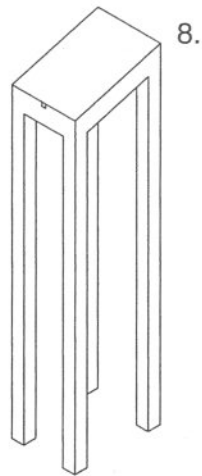
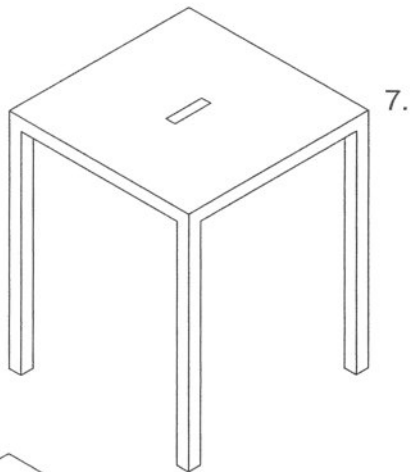
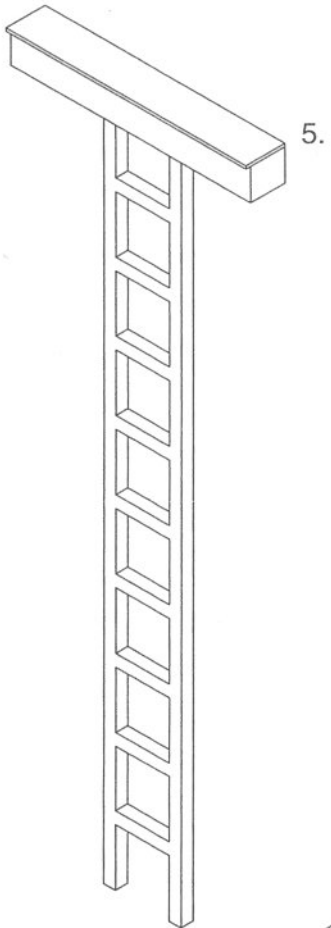

1. Parasite light

This light is a 'needy object' - it only works when it is placed near an electronic product. Its shape provides a place to put an electronic product like a radio, and allows the lamp to be integrated into a stack of books to achieve the right height. The parasite light does not feed off EM fields and is in fact battery powered. Like the nipple chair, it uses an electric field sensor to relate the intensity of its function - in this case the amount of light emitted from 20 LEDs - to the strength of the field it senses.

2. Compass table

This table reminds you that electronic objects extend beyond their visible limits. The 25 compasses set into its surface twitch and spin when objects like mobile phones or laptop computers are placed on it. The twitching needles can be interpreted as being either sinister or charming, depending on the viewer's state of mind. When we designed the compass table, we wondered if a neat-freak might try to make all the needles line up, ignoring the architectural space of the room in favour of the Earth's magnetic field.

3. Nipple chair

An electric field sensor and antenna are mounted beneath the seat of the chair. When the chair is placed in an electromagnetic field, two nipples set into the back start to vibrate, and the sitter is made aware of the radio waves penetrating their torso. It is up to them whether they stay and enjoy the gentle buzz, or move to a 'quieter' spot. As fields can also flow up through the sitter's body from electric wiring running underneath the floor, the chair has footrests so that you can isolate your feet from the ground. We like that it is slightly anthropomorphic; it's as though you are sitting on its lap.

4. Electro-draught excluder

This object is a classic placebo. Though the draught excluder is made from conductive foam, it is not grounded, and therefore does not really absorb radiation. We were interested in whether or not it would make the owner feel more comfortable. If you are working near a TV, for example, you might place the object between you and the TV to create a sort of shadow - a comfort zone where you simply feel better.

5. Loft

This lead-clad box on top of a ladder is a place to store precious magnetic mementoes such as answerphone messages, audio cassettes or floppy discs away from potentially harmful electromagnetic fields. It is a loft for people who live in flats. This object signals to visitors that you have a special place for special items, but that it is out of bounds. Accessing the loft might become part of a ritual.

6. Electricity drain

Some people who are hyper-sensitive to electricity drain excess electricity from their bodies to alleviate their symptoms. They wrap a piece of wire around their fingers which is connected to a plug that only has an earth pin. This literally grounds the person, by enabling electricity to flow from the body out into the system. This stool works in the same way: you plug it in and sit naked on a stainless steel plate in the seat. We are particularly interested where people will keep this object: in the bathroom? Bedroom? Sitting room? Is it a hygiene product, meditative piece or functional chair?

7. GPS table

This table has a global positioning sensor inside it. It can only display its position in the world when it has a clear view of the satellites, the rest of the time it is lost and indicates this fact. The ideal owner will need a conservatory or large window, or a garden so that they can at least bring the table outdoors from time to time so it can connect with a satellite and fulfil its potential. We like the idea that people might feel a little cruel keeping it indoors.

8. Phone table

This table is an attempt to domesticate the mobile telephone, whose synthetic and urgent squawk can be difficult to resist. On returning home, the phone is placed inside the table with its ringer switched off. Whenever the phone is called, the top of the table glows gently. The table suggests how electronic objects can use a more gentle language to capture our attention or mediate human contact. When it does glow, it is much easier to resist than a ringing phone. The phone table can be positioned behind the TV if a call is expected, or out of sight if you would prefer not to be disturbed.

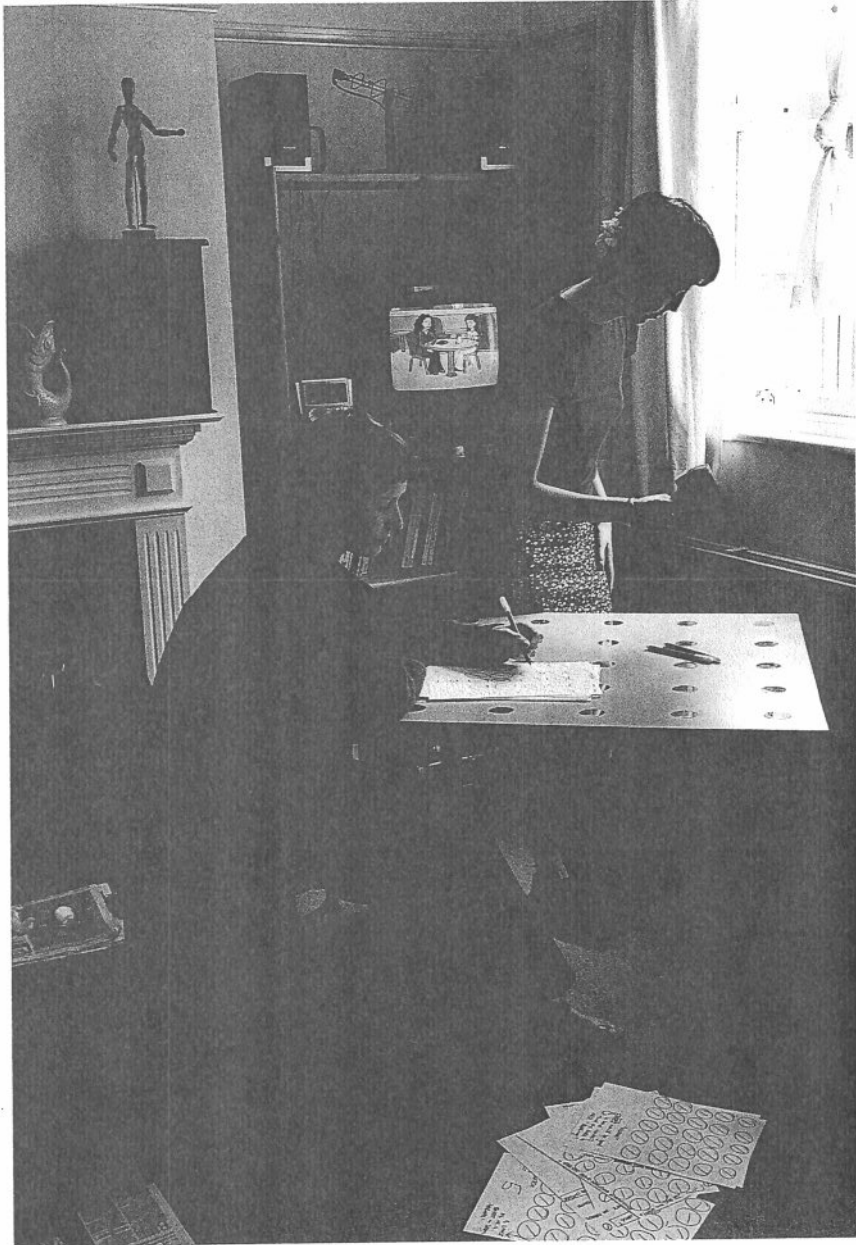

Diane & Arabella

9/06/01

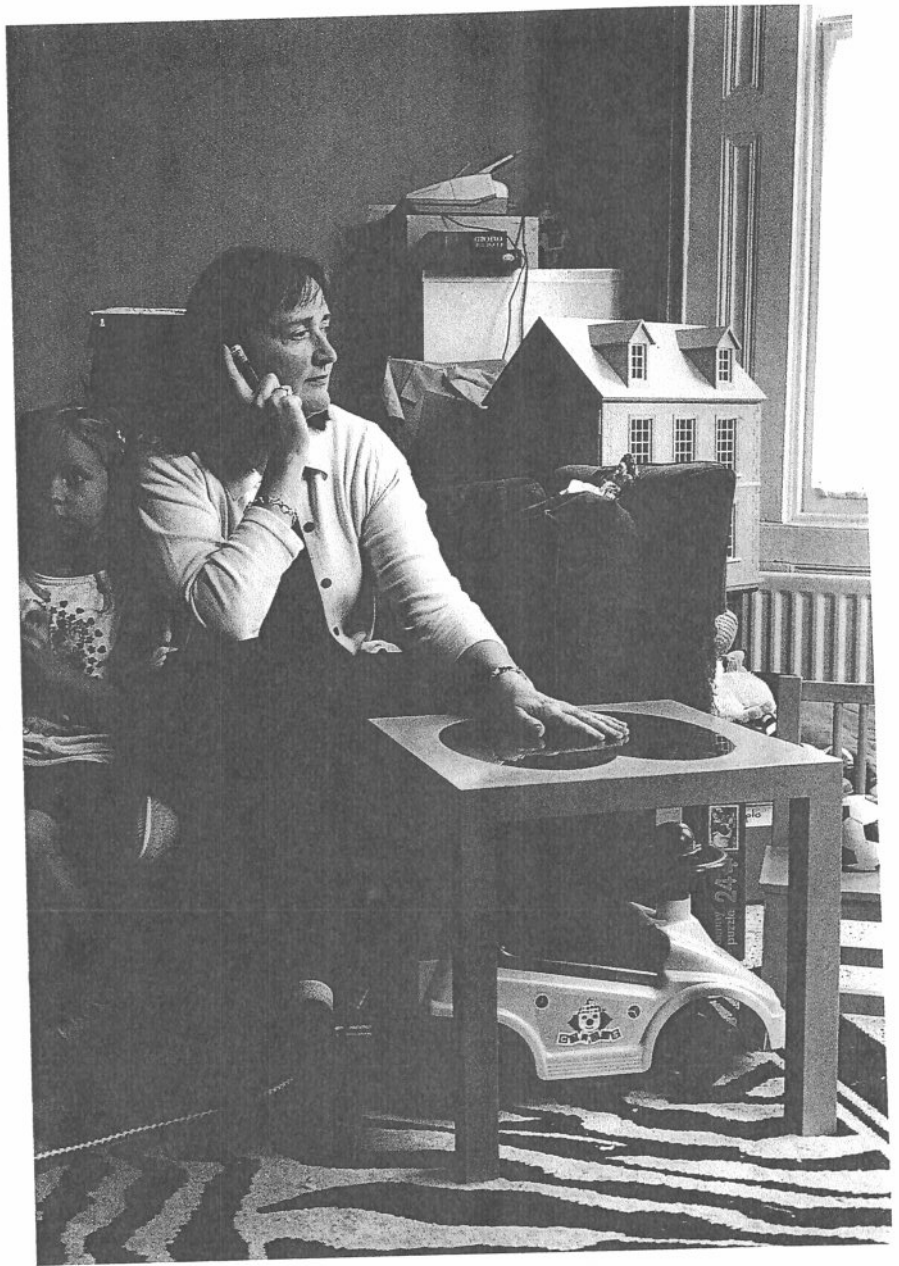

Emma & Constance

11/06/01

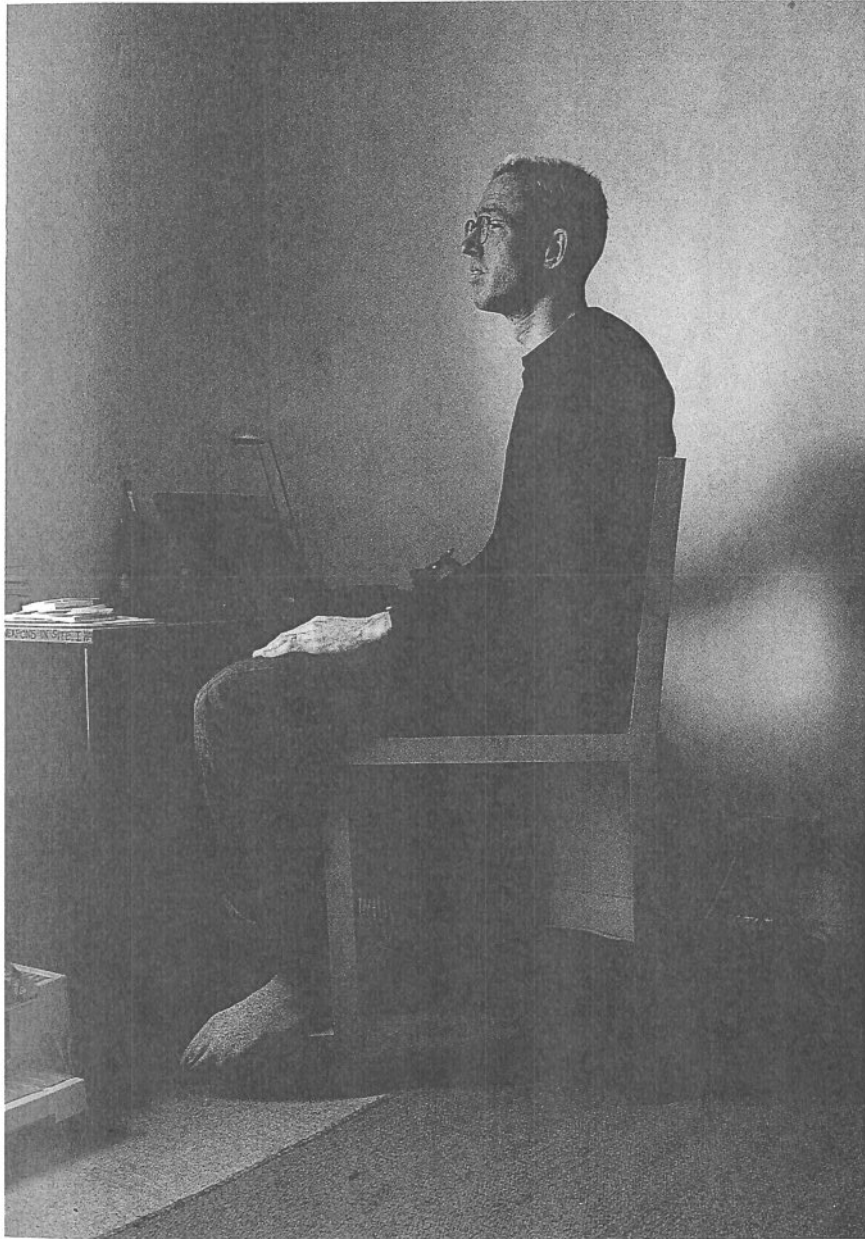

Neil

11/06/01

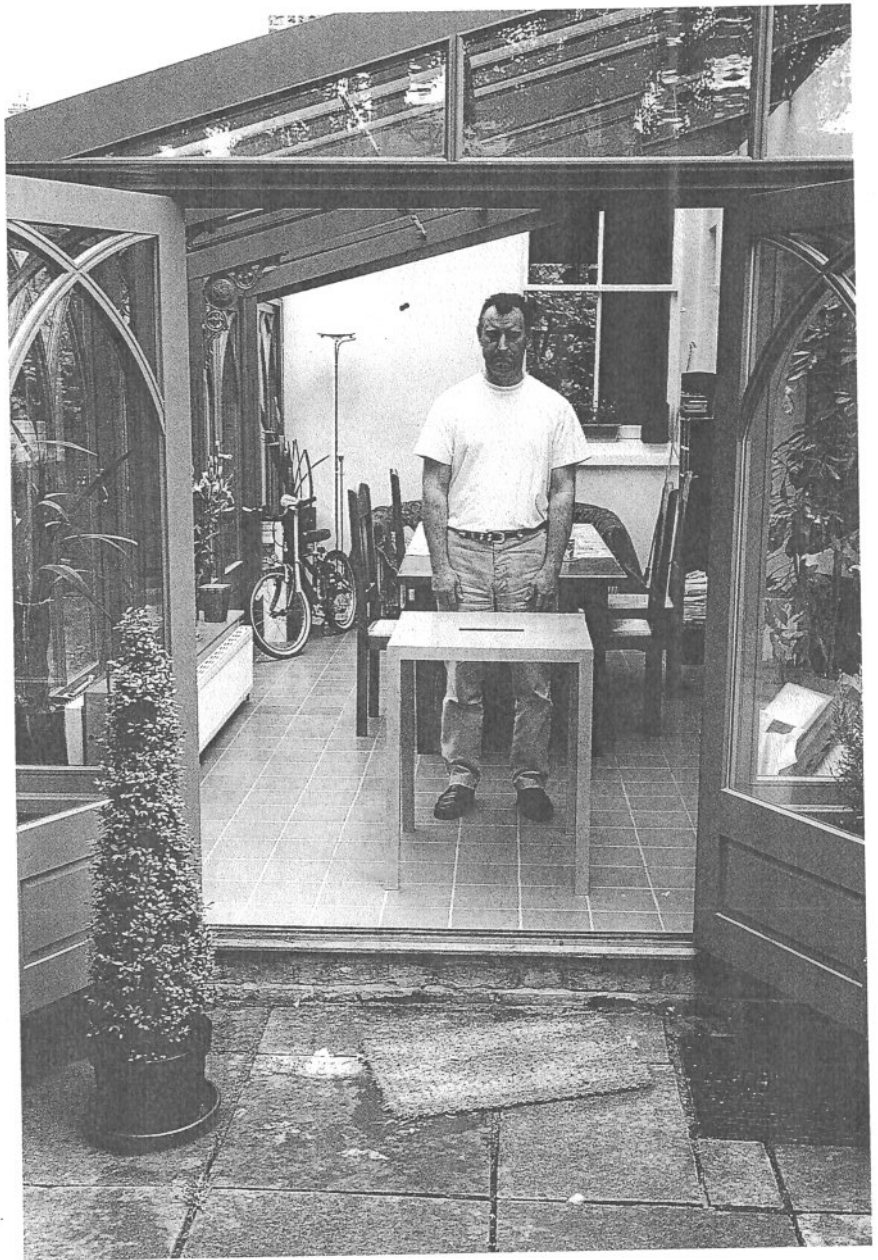

Dick

10/06/01

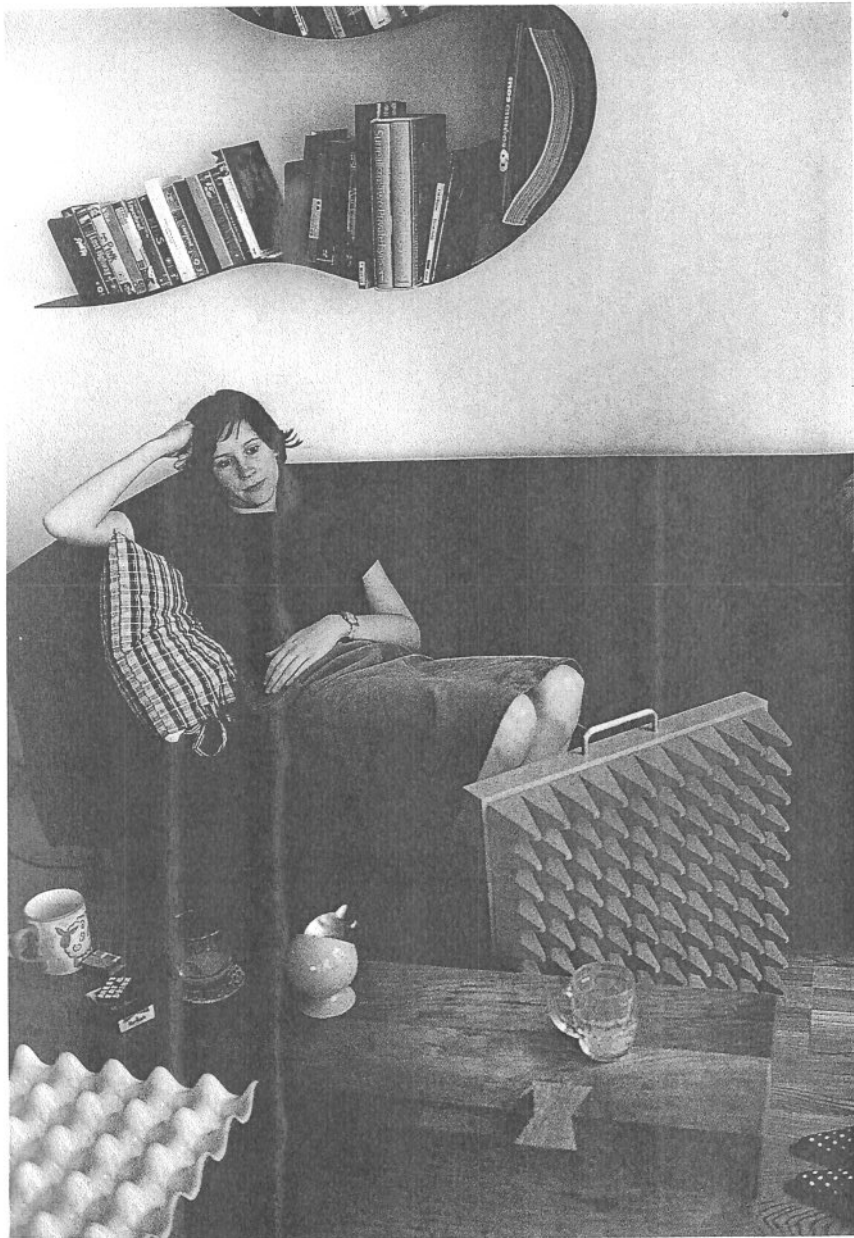

Lauren

6/07/01

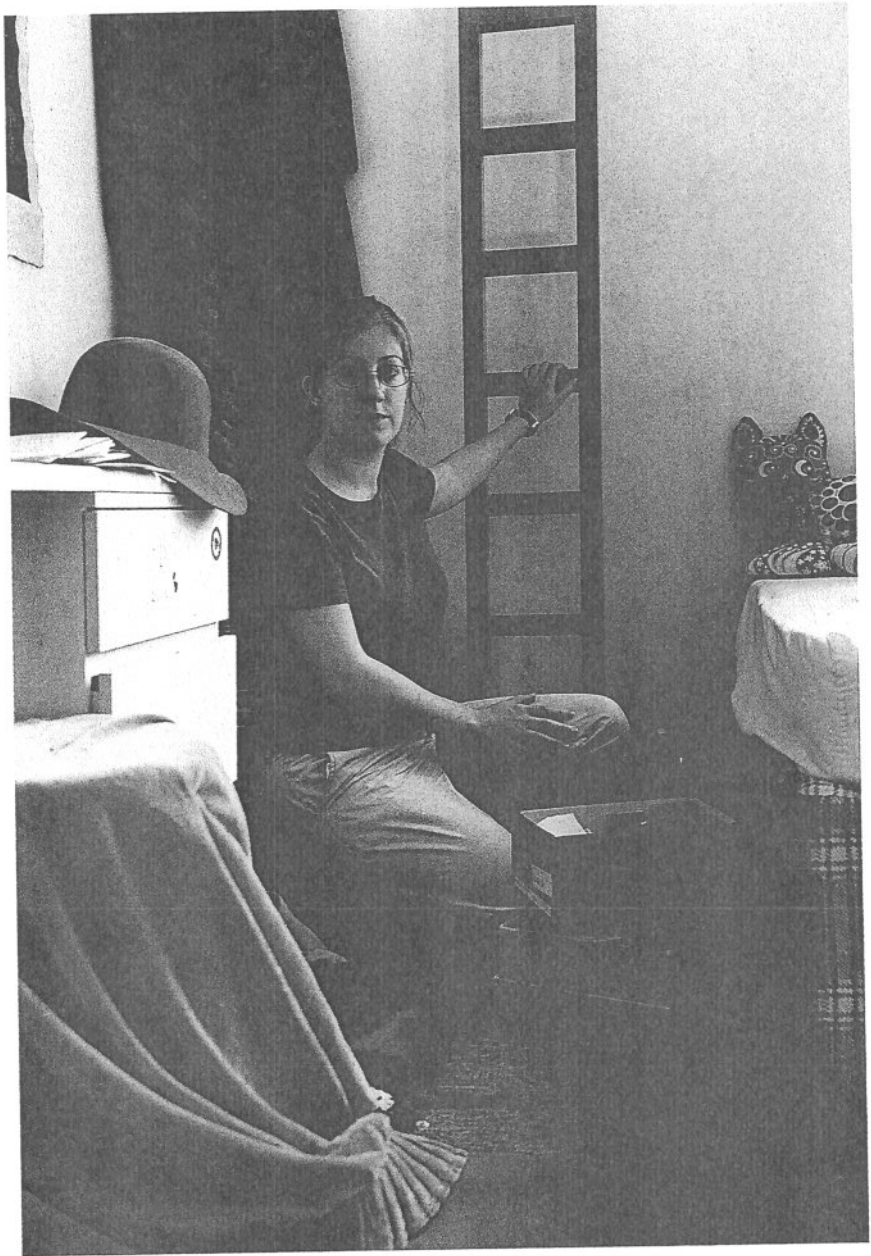

Sophie

7/07/01

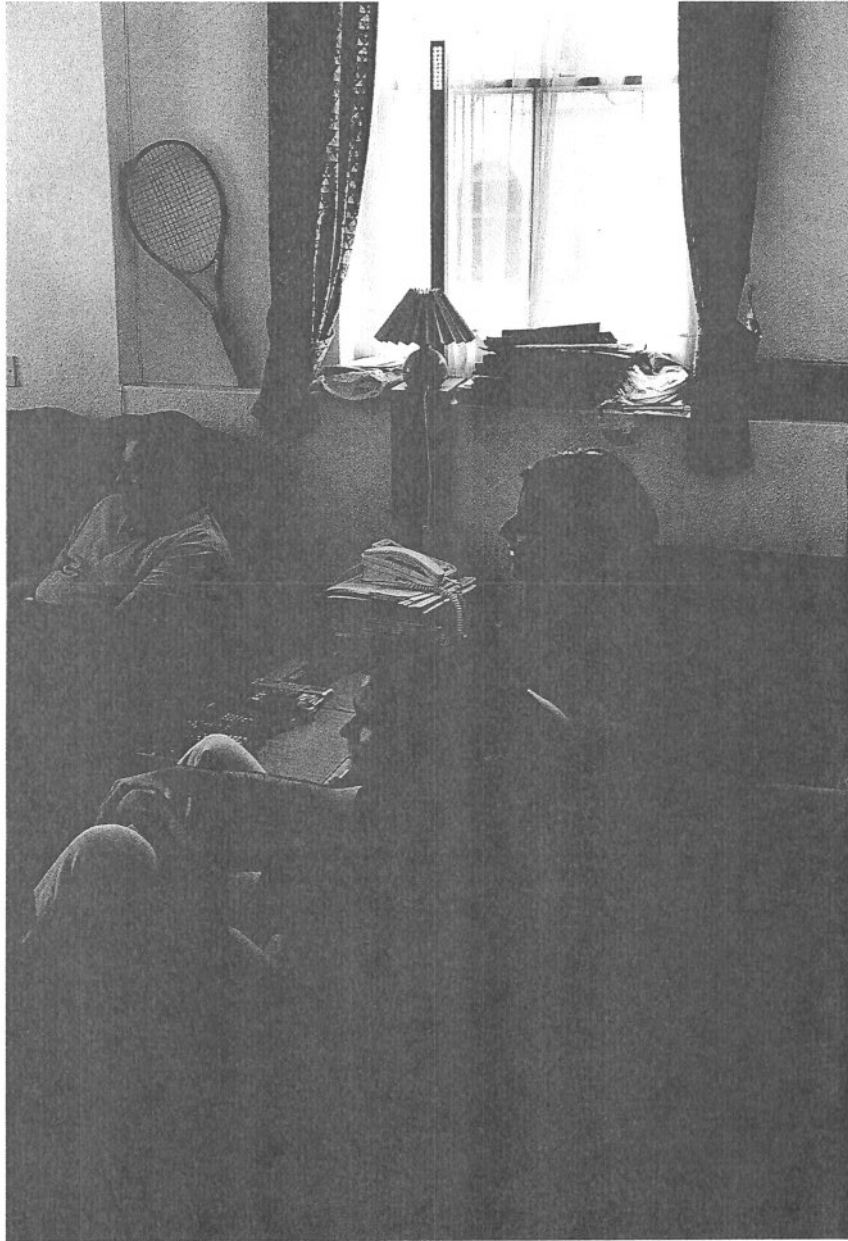

Denis, Harry & Lida

9/07/01



Tracey

5/07/01



Electricity Drain - Emma and Constance (aged 3)

When you talked to your friends, how did you describe the object?

A table that's supposed to drain the additional crackling waves of electricity and radiation humming around in your room. I am personally very sensitive to static. There are certainly times when you have lots of radio waves whizzing around in this room, particularly. So that's how I've described it: as something that I hope would have an effect on those potentially harmful invisible things flying around.

Where is the object now? Where has it ended up in your home?

It is by the television in the middle of our sitting room, in the hub of activity really. I certainly spend 90% of my time at home in here.

Why wouldn't you consider having it in the bedroom or bathroom or any other area in the house, do you think?

I suppose because in the bedroom I only use light, but in here there are so many different sorts of electrical equipment.

What did you actually use it for?

Apart from it just being there, my daughter would play with it sometimes, she would put toys on it and so on. It was used as a sort of passing place for objects going on to other places in the house, and newspapers and that kind of thing.

Would you sit on it as a chair?

Yes, it did get sat on sometimes.

So did you try any experiments?

When I was using my mobile phone I put my hand on it sometimes to see if it would stop my fillings hurting.

Did that work?

It did have a slight effect. I think I could be on the phone a bit longer without my fillings hurting. I certainly used it for static when I was ironing, nylon stuff would crackle and I would put it on there. The static definitely drained out. I tried to have my daughter sit on it when I was brushing her hair, but she wasn't interested.

The television suffers from a magnetic field problem - the top of the picture disappears every now and then, and apparently that is to do with the magnetic field. So we were hoping that something would happen magically, that's why it's beside the television. But that hasn't actually happened, I'm afraid. I also put the aerial on it as we were having problems getting a good enough picture.

Does that help?

Sometimes I think it helped, yes.

Has the experience of looking after the object had any effect on the way you think about electromagnetic waves at all?

It certainly made me realise how much we must have in the house, because it has made me aware of how many objects are on. We have had a lot of strange experiences in here. Light bulbs - they don't just go out, they'd bang. We had about six months of the top lights not working at all. And I have to say, whether it is to do with the table or not, they are now working and they just seemed to heal themselves.

Have there been other experiences of electronic things? Do you have any theories why?

I just don't know why, but I am very prone to static. I was with my daughter in Safeway in High Street Kensington about six weeks ago when as soon as I walked in I gave her an electric shock. And I kept giving her shocks, I gave her five shocks and she began to get upset and I kissed her and I gave her another shock and she started crying. I was wiping her tears away and while I was doing that, I was giving her electric shocks and I actually had to get someone else to take her out of the trolley and put her down because I was afraid to touch her while we were in the shop. It was very, very bizarre. It's just me and certain shops - as soon as I walk in, I actually feel a bit weird. If I touch things or my children, I give them shocks.

Did you show the object to other people?

I told everybody about it when they came in and some people were fascinated and some people pooh-poohed it, as I expected. Some people were quite worried about it and I had to explain that the plug was just an outlet and not an inlet and then they seemed reassured. But there were so many who were quite worried about what an earth it might be. I had a lot of trouble trying to explain what it was supposed to do because I wasn't sure whether it was doing it myself.

Do you think it actually drains?

Yes, I think so. As I said, when I was on the phone my fillings hurt. That certainly made a difference. It doesn't make me calm and serene, particularly.

Could it be described as a gadget?

No, I certainly saw it as a table. It is more of a special table rather than a gadget that looks like a table.

How do you feel about the idea of plugging something like a chair in, like you would an iron or a cooker?

It is quite strange. People have noticed that it's not something that you would normally do. It's got a slightly wacky character and I like that. I love the fact that it is ironing cable - like an appliance. I wouldn't have liked it so much if it was just all plastic coating.

What kinds of people do you think might want to own an object like this?

I'd say anyone who had lots of electronic gadgets around them and was concerned about the effect they might be having, but who is very happy to have something simple and contemporary and not demanding. It's perfect really to have it just sitting there doing its work, without any input.

Do you think many people believe that it actually works?

Probably not. I can see people wanting to have something with quite a dramatic effect, if they felt something tingle when they touched it or if it cut their phone out, they would consider that to be working.

So you see it as constantly working on the environment - you plug it in and everything in the room has been absorbed. Is that right?

Yes it is, I imagined it sort of quietly working away like a bunch of flowers. You know, something going on, something quite beneficial, very gentle, but you don't necessarily know. That's how I imagine it.

So if we were going to make another object like this how would you redesign it?

If there could be some kind of gauge which would show you when something was working... I think that is all that it would need.

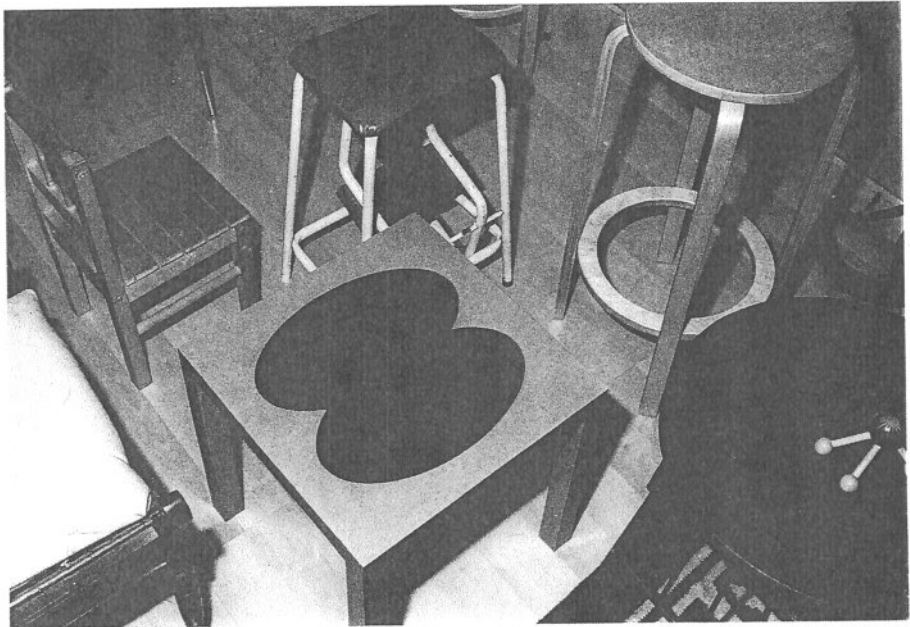

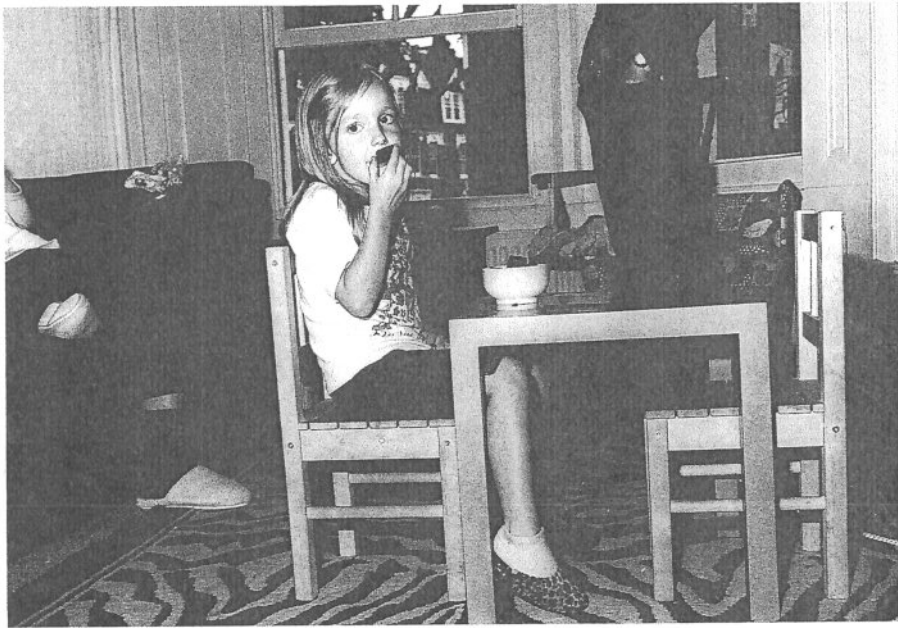

Have there been any discussions or disagreements over the meaning?

Certainly, with my son, we talked about it quite a lot. About whether or not it works, how it would work and so on. Not particularly, otherwise. It's passive and you can't really do anything with it, and that's probably why people haven't interacted with it more.

How would you feel if more objects were to have electronic functions?

Oh yes, I like that idea. It would be very nice to have something like a breakfast bar which is the focus of the whole house. It would be lovely to press a button and have your legs warmed in the morning. You could have mobile phone battery re-chargers under there, you could have all sorts of things incorporated into that.

So you're quite happy living with more and more technology. You seem to be welcoming it into your environment.

Some of it is much too complicated to use. I can't stand fifty page instruction books... I think they should be very easy. Like a piano that you can just open and play something, and then as you get cleverer, you can learn how to do more complicated things with it.

When you get a function that is like this, quite esoteric, do you prefer that?

Well, its function is less obvious, isn't it? I am always happy to try things out, and if the effect of them is minor or ephemeral or possibly not there at all, that makes it more interesting, I think.

Would you rent furniture if you could?

I'd love to, that would be wonderful. I like the idea of change. I love moving furniture around, because if you're not going to move house all the time it gives you a fresh aspect.

Do you think this is a good placebo object?

Definitely. Despite the fact that I wasn't really sure whether or not it was working, I was quite happy to go and sit there and put my hand on it while I was on the phone because I felt it might work or have some effect. And I'd put my ironing on it when I had finished: 'It's special now, it's been de-staticed'. So I certainly found it to have a beneficial effect, even if it was very slight.